



(REVIEW ARTICLE)



## IOT based noise pollution and water quality monitoring system

Srushti Prashant Hundekar \*, Aishwarya Shrikant Varur, Vijeth Chandrashekhar Shetty, Venkatesh Shankar and Kartik Kulkarni

*Computer Science and Engineering KLS VDJIT Haliyal Dist. Uttara Kannada, Karnataka, India.*

International Journal of Science and Research Archive, 2024, 12(01), 900–913

Publication history: Received on 12 April 2024; revised on 21 May 2024; accepted on 24 May 2024

Article DOI: <https://doi.org/10.30574/ijrsra.2024.12.1.0906>

### Abstract

Presently, noise pollution has become a very big issue around the world. The adverse effects of this pollution include hearing impairment, negative social behaviour, annoyance, sleep disturbance and intelligibility to understand people's speech. In learning context, noise can affect understanding and behaviour of people and places with high noise level are not suitable for learning and teaching process. Internet of Things (IoT) technology is one of the best choices to monitor the noise or sound intensity in the environment for the safety of human being.

The aim of this paper is to deliver a development of an IoT based noise monitoring system comprises of a sound sensor, an IoT platform called Node MCU, LCD and LEDs. The system will provide a real-time alert if the noise exceeds the threshold noise limit set by Environmental Department of Health standard. Equipped with an Android application, the data from the sound sensor will be transferred into the cloud server and subsequently transferred into the app for display and to enable remote monitoring.

A case study is carried out using the developed prototype to ascertain the noise comfort for University Technology Malaysia (UTM) students for studying or learning purpose. The sound level is measured for two different days during weekend and weekday.

Based on Chartered Institution of Building Service Engineers (CIBSE), 60dBA is the permissible ambient level and any readings that above 60dBA can interrupt speech intelligibility.

**Keywords:** Real time uses in Schools; Colleges; Library; HealthCare Centre; Factories

### 1. Introduction

Pollution is an important and major factor that is Negatively affecting the quality of the lives of millions. Most of the pollutants in the environment are a result of untreated emissions and the release of industrial wastes from factories to the environment, with the growing world population and industry advancement, Environmental pollution became a big concern.

Many Processing and manufacturing industries majorly contribute to 2 types of pollution

- Noise pollution
- Water quality

Noise is defined as the unwanted, loud and unpleasant sound, if this noise cause disturbance, irritation, or negatively effects causing harm to humans and animals then it is called noise pollution, according to WHO if the sound exceeds

\* Corresponding author: Srushti Hundekar

75dB then it is considered as noise pollution. WHO recommends noise levels should be kept below 65dB during daytime and during night time noise levels must be kept below 30dB. noise pollution can be caused by various reasons like air traffic noise, traffic noise but one of the major reasons for noise pollution is heavy industrial machines for example a pneumatic drilling machine in the construction sites can produce up to 110dB noise. Noise pollution has a serious effect on both humans and animals such as constant loud noises that can result in hearing loss, respiratory agitation, high blood pressure, severe headaches, and many psychological disorders.

Similarly, the Major reason for water pollution through industries is caused by discharging the untreated industrial waste that is generated during various processing activities, the industrial wastes include asbestos, lead, mercury, nitrates, phosphates, sulfur, and other petrochemicals, etc.

The untreated acidic effluents which are released to natural reservoirs decrease the pH value of the reservoir water resulting in a decreased microbial activity affecting the growth of the algae and other aquatic plants resulting in a decrease in the level of BOD (biological oxygen demand) that is the level of dissolved oxygen in the water which affects in the breathing of the aquatic animals resulting in their death.

### 1.1. Major reasons for Industrial pollution

- Lack of policies to control pollution.
- Unplanned industrial growth

## 2. Literature survey

The paper titled "IoT Based Industrial Air, Water, and Noise Pollution Monitoring System" published in the International Research Journal of Engineering and Technology (IRJET) addresses the critical issue of environmental imbalance caused by unchecked industrialization and globalization. It highlights the detrimental impact on essential elements of the ecosystem— air, water, and soil—due to the release of untreated toxic elements into the environment.

The primary focus lies on designing an efficient system capable of monitoring and controlling pollutants to mitigate the adverse effects on human and animal health. The introduction provides a comprehensive overview of the four major types of pollution—air, water, soil, and noise— attributed.

It emphasizes the alarming statistics of air pollution-related deaths in India and identifies untreated industrial waste as a significant contributor to water pollution, affecting aquatic life and reducing water quality. Thermal pollution, caused by drastic temperature changes in natural water bodies due to industrial processes, is also discussed alongside the impact of noise pollution on human health, emphasizing the need for stringent control measures.

**Table 1** Literature survey Table

SI.NO	Paper Title	Authors	Year of Publication	Outcomes
1.	Smart IOT Based Vehicle Noise Pollution Monitoring	P. Patil	2021	System Monitor the noise pollution created by vehicles.
2.	IOT Based smart Water Quality Monitoring System	Monira Mukta	2020	The ultimate goal of this is to observe the quality of water samples by designing a Smart Water Quality Monitoring (SWQM) using IOT
3.	Development of Real-time IOT Based Noise Monitoring System	Dharmaraj Sundaram	2021	The Proposed system is capable of detecting noise levels both indoor and outdoor settings.
4.	An IOT Based Smart Water Quality Monitoring System	Jerom B.Ajith	2020	The proposed system monitors the quality of water relentlessly with the help of IOT devices.

### 3. Methodology

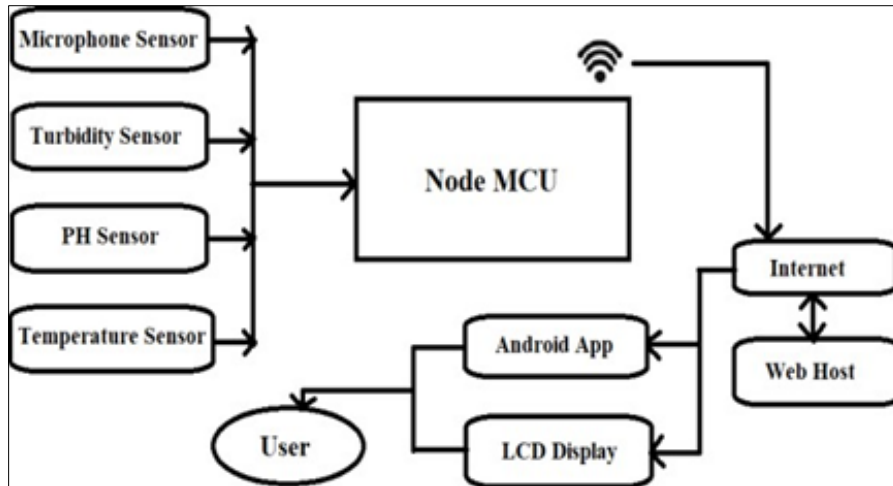

**Figure 1** Architecture diagram of Noise Pollution and Water Quality System

The above figure 1 shows the Architecture diagram of Noise Pollution and Water Quality Monitoring. Noise pollution refers to excessive or disturbing noise that disrupts the environment and human health. Monitoring systems use sensors to measure noise levels, identify sources, and implement control measures. Water quality monitoring involves sensors to assess parameters like pH, oxygen levels, and pollutants in water sources. It helps ensure water safety, detect contaminants, and maintain quality standards.

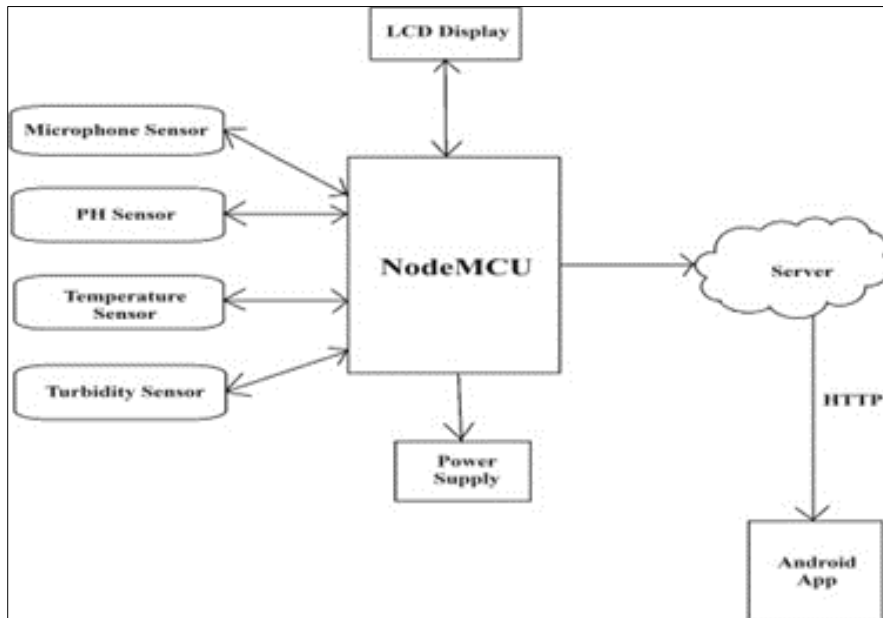

**Figure 2** Block Diagram of Noise Pollution and Water Quality Monitoring System

The above figure 2 shows the Block diagram of Noise Pollution and Water Quality Monitoring System. An IOT based noise pollution system using Android multiple components. In a block diagram, you'd likely have sensors detecting noise levels, sending data to a microcontroller or IOT device which then transmits this information to an android app via the internet. Water Quality Monitoring system. An IOT based Water Quality Monitoring System, the dataflow diagram typically involves several interconnected components. Sensors placed in water sources collect data on various parameters like PH, Turbidity, Dissolved Oxygen, etc.

### 3.1. Sequence Diagram

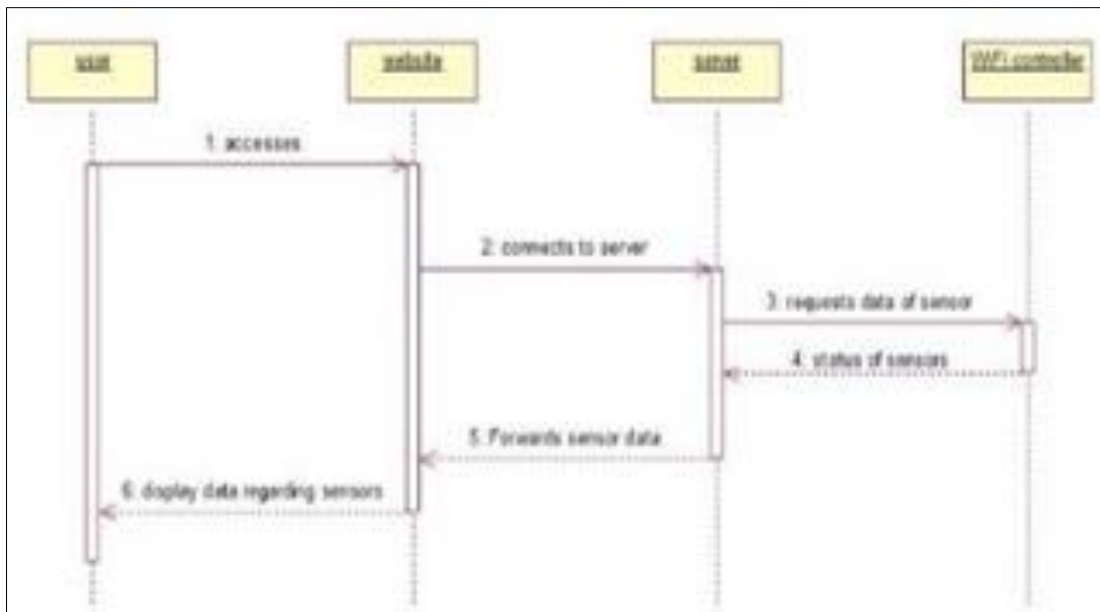

**Figure 3** Sequence Diagram of Noise Pollution and Water Quality Monitoring System

The above figure 4.3 shows the Sequence diagram of Noise Pollution and Water Quality Monitoring System. A sequence diagram illustrates the interactions between different objects or components in a system over time. In the context of an IoT-based monitoring system for noise pollution and water quality, there would be several components involved, such as sensors, data processing modules, and a central monitoring station. This sequence diagram provides a high-level overview of the interactions and workflows within an IoT-based noise pollution and water quality monitoring system, from data acquisition to alert generation and user interaction.

- User interacts with the system through a Monitoring System to request and view data.
- Sensor device continuously collects environmental data and sends it to the Data Processor.
- Data processes and stores data in the Database.
- Monitoring System retrieves data from the Database and displays it to the User.
- If any data point exceeds the set thresholds, the Notification System sends alerts to the User.

## 4. System implementation

### 4.1. Components description

#### 4.1.1. Node MCU(ESP32)



Above mentioned figure shows Node MCU sensor. The Node MCU (Node Micro Controller Unit) is an open- source software and hardware development environment built around an inexpensive System-on-a-Chip (SoC) called the

ESP32. The ESP8266, designed and manufactured by Express if Systems, contains the crucial elements of a computer: CPU, RAM, networking (WiFi), and even a modern operating system and SDK. That makes it an excellent choice for Internet of Things (IoT) projects of all kinds.

#### 4.1.2. NodeMCU ESP32 Specifications & Features

- Microcontroller: Tensilica 32-bit RISC CPU Xtensa LX106
- Operating Voltage: 3.3V
- Input Voltage: 7-12V
- Digital I/O Pins (DIO): 16
- Analog Input Pins (ADC): 1
- UARTs: 1
- SPIs: 1
- I2Cs: 1
- Flash Memory: 4 MB
- SRAM: 64 KB
- Clock Speed: 80 MHz
- Small Sized module to fit smartly inside your IoT projects
- Small graphs for each parameter

#### 4.1.3. Turbidity Sensor



Above figure represents the Turbidity sensor. Turbidity sensors are a piece of equipment used to measure the cloudiness or haziness and the concentration of total dissolved/suspended solids of a solution. A turbidity sensor is an analytical sensor that measures turbidity. They are highly useful and effective instruments to identify the clarity and particle content in a solution, like water. Turbidity sensors are used to reduce waste, improve yields, and analyze water quality in a wide range of industries. Turbidity sensors measure the amount of light that is scattered by suspended solids in a liquid, such as water. When the concentration of total suspended solids (TSS) and total dissolved solids (TDS) in a liquid increase, the turbidity also increases.

#### What is Turbidity in Liquid?

Turbidity is the degree or level of cloudiness or haziness of a liquid. This happens due to the presence of large numbers of invisible particles (with the naked eye) similar to white smoke in the air. When light passes through liquids, light waves get scattered Due to the presence of these tiny particles. The turbidity of a liquid is directly proportional to the free suspended particles that is if the number of particles increases turbidity will also increase. Our turbidity sensors and transmitters are used in water, wastewater, food & beverage, chemicals, life sciences, power, etc. Sensor selection depends on the application: choose nephelometric sensors for media with low turbidity such as potable water. To measure high turbidity, for example in wastewater, apply suspended solids sensors.

#### Turbidity measurement with absorption sensors

Absorption turbidity meters measure the light absorbance of particles in a medium. They feature an LED lamp and a light detector that is positioned directly opposite the lamp. Between them, particles in the medium attenuate the emitted light, which is converted by the detector first into an electric signal and then into the final turbidity value. Our advanced sensors feature a second lamp-detector-arrangement using a different path length, thus improving the reliability of the measurement.

#### 4.1.4. Microphone sensor

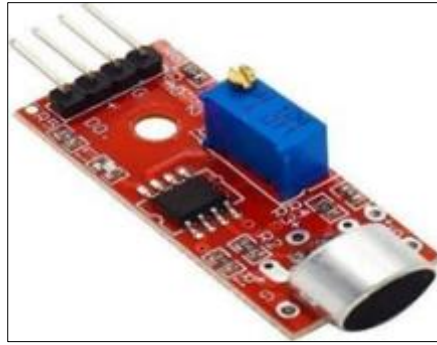

The above figure 5.1.4 represents Microphone sensor. A Microphone sensor helps an electronic product capture sound waves to process. Microphones are transducers which convert sound energy into electrical energy. Morden day consumer portable electronic devices such as tablets, smartwatches, mobile phones, earbuds, Headphones and laptops widely uses board-level microphone sensors for various reasons.

#### 4.1.5. Specifications

The sound sensor module specifications are given below.

- Wide operating voltage of 3.3V to 5V DC.
- Operating current of 4mA to 5mA.
- The voltage gain of 26dB.
- The high sensitivity of 1KHz.
- Microphone's dB level of 52 to 48dB.
- The impedance of the microphone is 2.2-kilo ohms.
- The frequency of the microphone is 16KHz to 20KHz.
- The signal-to-noise ratio is 54dB.
- LM393N comparator with threshold present is used.
- The induction distance is 0.5 meters.

#### 4.1.6. PH level sensor



The above figure shows figure of PH sensor. PH sensor is one of the most important tools for measuring pH and is commonly used in water quality monitoring. This type of sensor is capable of measuring alkalinity and acidity in water and other solutions. When used properly, pH sensors can ensure the safety and quality of products and processes that occur in wastewater or manufacturing plants. In most cases, the standard pH range is represented by a value in the range of 0-14.



#### 4.1.7. Working Principle of PH Sensor

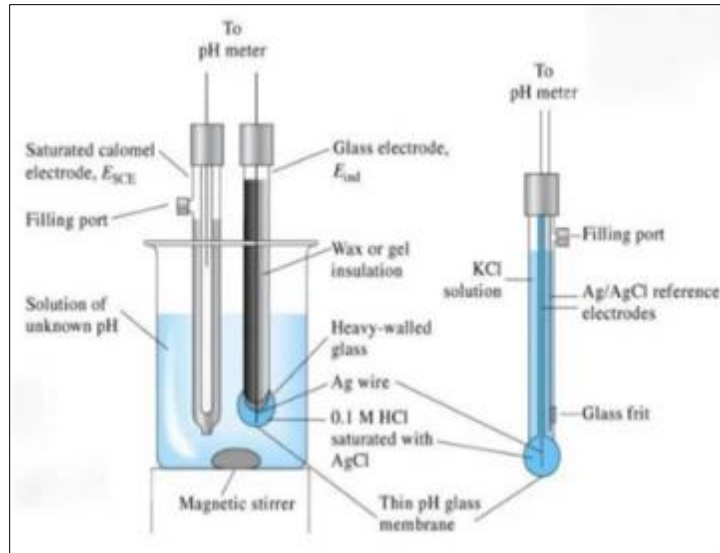

A unit of measure that measures the acidity or alkalinity of a solution using a logarithmic scale with seven as neutral, where lower values are more acidic, and higher ones are more alkaline, is known as pH. The pH equals negative log<sub>10</sub> of the hydrogen ion concentration (c), given in moles per liter

$\text{pH} = -\log_{10}[\text{H}^+]$  where,  $[\text{H}^+]$  = the solution's hydrogen ion concentration, expressed in moles per liter. In an aqueous solution, the product of hydrogen ion concentration and hydroxyl ion concentration is constant, and the pH is equal to the negative logarithm of the concentration of hydrogen ions. A pH meter is a statistical tool that monitors the hydrogen-ion activity in water-based solutions, determining its acidity or alkalinity represented as pH.

#### 4.1.8. Temperature Sensor



The above figure shows figure of Temperature Sensor. A temperature sensor is a device that is designed to measure the degree of hotness or coolness in an object. The working of a temperature meter depends upon the voltage across the diode. The temperature change is directly proportional to the diode's resistance. The cooler the temperature, the lesser will be the resistance, and vice-versa. The resistance across the diode is measured and converted into readable units of temperature (Fahrenheit, Celsius, Centigrade, etc.) and, displayed in numeric form over readout units. In the geotechnical monitoring field, these temperature sensors are used to measure the internal temperature of structures like bridges, dams, buildings, power plants, etc.

#### 4.1.9. LCD Board

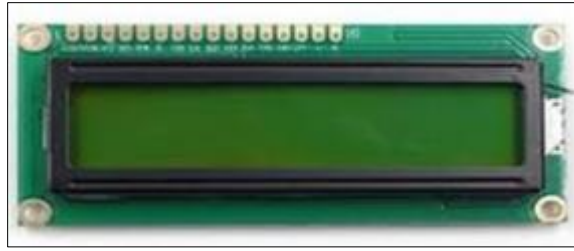

The term LCD stands for liquid crystal display. It is one kind of electronic display module used in an extensive range of applications like various circuits & devices like mobile phones, calculators, computers, TV sets, etc. These displays are mainly preferred for multi-segment light-emitting diodes and seven segments. The main benefits of using this module are inexpensive; simply programmable, animations, and there are no limitations for displaying custom characters, special and even animations, etc. LCDs are available to display arbitrary images (as in a general-purpose computer display) or fixed images with low information content, which can be displayed or hidden: preset words, digits, and seven-segment displays (as in a digital clock) are all examples of devices with these displays.

#### LCD 16×2 Pin Diagram

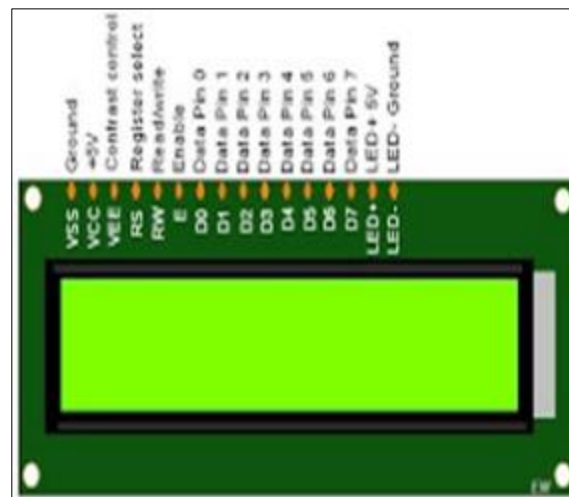

- Pin1 (Ground/Source Pin): This is a GND pin of display, used to connect the GND terminal of the microcontroller unit or power source.
- Pin2 (VCC/Source Pin): This is the voltage supply pin of the display, used to connect the supply pin of the power source.
- Pin3 (V0/VEE/Control Pin): This pin regulates the difference of the display, used to connect a changeable POT that can supply 0 to 5V.
- Pin4 (Register Select/Control Pin): This pin toggles among command or data register, used to connect a microcontroller unit pin and obtains either 0 or 1(0 = data mode, and 1 = command mode).
- Pin5 (Read/Write/Control Pin): This pin toggles the display among the read or writes operation, and it is connected to a microcontroller unit pin to get either 0 or 1 (0 = Write Operation, and 1 = Read Operation).
- Pin 6 (Enable/Control Pin): This pin should be held high to execute Read/Write process, and it is connected to the microcontroller unit & constantly held high.
- Pins 7-14 (Data Pins): These pins are used to send data to the display. These pins are connected in two-wire modes like 4-wire mode and 8-wire mode. In 4-wire mode, only four pins are connected to the microcontroller unit like 0 to 3, whereas in 8-wire mode, 8-pins are connected to microcontroller unit like 0 to 7.
- Pin15 (+ve pin of the LED): This pin is connected to +5V
- Pin 16 (-ve pin of the LED): This pin is connected to GND.



#### 4.1.10. Android Studio



Google's Android operating system is a mobile-based open-source platform. Nowadays, most smartphones, tablets, televisions, and other devices like even your Fitbit run on android. Android is based on top of the Linux kernel(modified version). Android has been evolving since the year 2003, and till now, it has come across many versions. Google being the lead for android, has been updating android from time to time, making new features and improving security patches for a better user experience.

Each Android version has an API level with it. API level is a numerical value that is put for each version of android to identify it uniquely. The API level makes your task easy in placing the SDK tools you require for the development. For best practices, you should build an app that is supportive at most of the API levels. Android itself being widely used across the world makes it essential for developers to choose android.

#### 4.1.11. Features

##### Interface

Android's default user interface is mainly based on direct manipulation, using touch inputs that loosely correspond to real-world actions, like swiping, tapping, pinching, and reverse pinching to manipulate on-screen objects, along with a virtual keyboard. Game controllers and full-size physical keyboards are supported.

##### Home screen

Android devices boot to the home screen, the primary navigation and information "hub" on Android devices, analogous to the desktop found on personal computers. Android home screens are typically made up of app icons and widgets; app icons launch the associated app, whereas widgets display live, auto-updating content, such as a weather forecast, the user's email inbox, or a news ticker directly on the home screen. A home screen may be made up of several pages, between which the user can swipe back and forth. Third-party apps available on Google Play and other app stores can extensively re-theme the home screen, and even mimic the look of other operating systems, such as Windows Phone. Most manufacturers customize the look and features of their Android devices to differentiate themselves from their competitors.

##### Status bar

Along the top of the screen is a status bar, showing information about the device and its connectivity. This status bar can be pulled (swiped) down from to reveal a notification screen where apps display important information or updates, as well as quick access to system controls and toggles such as display brightness, connectivity settings (WiFi, Bluetooth, cellular data), audio mode, and flashlight. Vendors may implement extended settings such as the ability to adjust the flashlight brightness.

##### Notifications

Notifications are "short, timely, and relevant information about your app when it's not in use", and when tapped, users are directed to a screen inside the app relating to the notification.[94] Beginning with Android 4.1 "Jelly Bean", "expandable notifications" allow the user to tap an icon on the notification in order for it to expand and display more information and possible app actions right from the notification.

## App lists

An "All Apps" screen lists all installed applications, with the ability for users to drag an app from the list onto the home screen. The app list may be accessed using a gesture or a button, depending on the Android version. A "Recents" screen, also known as "Overview", lets users switch between recently used apps. The recent list may appear side-by-side or overlapping, depending on the Android version and manufacturer.

## Navigation buttons



Front buttons (home, menu/options, go back, search) and optical track pad of an HTC Desire, a 2010 smartphone with Android OS.

Many early Android OS smartphones were equipped with a dedicated search button for quick access to a web search engine and individual apps' internal search feature. More recent devices typically allow the former through a long press or swipe away from the home button.

The dedicated option key, also known as menu key, and its on-screen simulation, is no longer supported since Android version 10. Google recommends mobile application developers to locate menus within the user interface. On more recent phones, its place is occupied by a task key used to access the list of recently used apps when actuated. Depending on device, its long press may simulate a menu button press or engage split screen view, the latter of which is the default behaviour since stock Android version 7.

### 4.1.12. Arduino IDE



The Arduino Software (IDE) makes it easy to write code and upload it to the board offline. We recommend it for users with poor or no internet connection. This software can be used with any Arduino board. There are currently two versions of the Arduino IDE, one is the IDE 1.x.x and the other is IDE 2.x. The IDE 2.x is new major release that is faster and even more powerful to the IDE 1.x.x. In addition to a more modern editor and a more responsive interface it includes advanced features to help users with their coding and debugging. Arduino IDE is an open-source software, designed by Arduino.cc and mainly used for writing, compiling & uploading code to almost all Arduino Modules. It is an official Arduino software, making code compilation too easy that even a common person with no prior technical knowledge can get their feet wet with the learning process.

## Features

- So, the benefit of microcontroller is the circuit is quite simple and small in size. Moreover, its flexible, suppose you want to change the time of turning ON bulb then what you need to do is simply change the coding and it will be changed, but in 555 timer circuits you need to change the components in order to do so.
- Suppose you want to work on PIC then you have to first design its basic circuit also need to design a power circuit to supply power to it and after that in order to upload the code in it, you have to buy a programmer/ burner as well.

- So, first of all you need to write the code for PIC Microcontroller and after that you need to upload code in it using a programmer and then place PIC microcontroller back into the circuit and test, which is quite lengthy plus also got hectic when you are working on some project because you have to test code again and again.
- By the way, now advance programmers like PICkit2 and PICkit3 can be plugged on board but still you have to design the basic circuit so coming to bottom line, in order to do project with PIC or Atmel microcontroller you have to do soldering etc.
- But that's not the case with Arduino Board, Arduino has built in programmer and the basic circuit in it. So what you need to do is simply plug in Arduino with your computer via USB cable, get its software and start uploading code and also start testing.
- So, you don't need to plug unplug or do anything, simply upload the code and test. Moreover, it also has some very efficient tools using which you can test your output as well quite easily. Arduino board also has the pins on which you can simply plug your devices and can turn them ON or OFF. So, hats off to Arduino team for providing us a simple board which has everything on it.

#### File

- New Creates a new instance of the editor, with the bare minimum structure of a sketch already in place.
- Open Allows to load a sketch file browsing through the computer drives and folders. Open Recent Provides a short list of the most recent sketches, ready to be opened.
- Sketchbook Shows the current sketches within the sketchbook folder structure; clicking on any name opens the corresponding sketch in a new editor instance.
- Examples Any example provided by the Arduino Software (IDE) or library shows up in this menu item. All the examples are structured in a tree that allows easy access by topic or library.
- Close Closes the instance of the Arduino Software from which it is clicked. Save Saves the sketch with the current name. If the file hasn't been named before, a name will be provided Closes all IDE windows.
- The same sketches open when Quit was chosen will be automatically reopened the next time you start the IDE. Page Setup It shows the Page Setup window.

---

## 5. Results and discussion

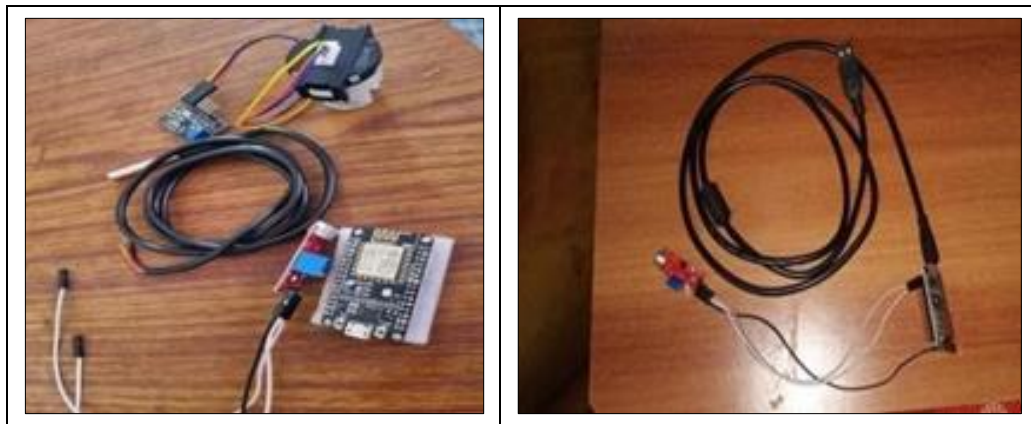

**Figure 4** This figure indicates the Iot based Noise Pollution and Water Quality Detector

The below figure 4 shows IOT based noise pollution detector system. The integration of IoT in noise and water pollution monitoring is expected to bring about a transformative shift in how we address environmental challenges, moving towards a more proactive, data- driven, and sustainable approach to pollution management. IoT sensors can be placed in rivers, lakes, and other bodies of water. They can transmit data in real- time to a central monitoring system. The data can be processed by a core controller, such as an Arduino model. The sensor data can be viewed on the internet using a Node MCU system implementing an IoT-based noise monitoring solution can lead to the identification of inefficiencies in production processes. By analysing real-time noise data, businesses can pinpoint areas where excessive noise occurs and take corrective measures.

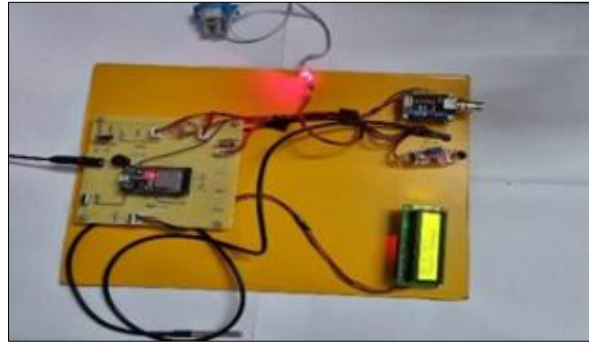
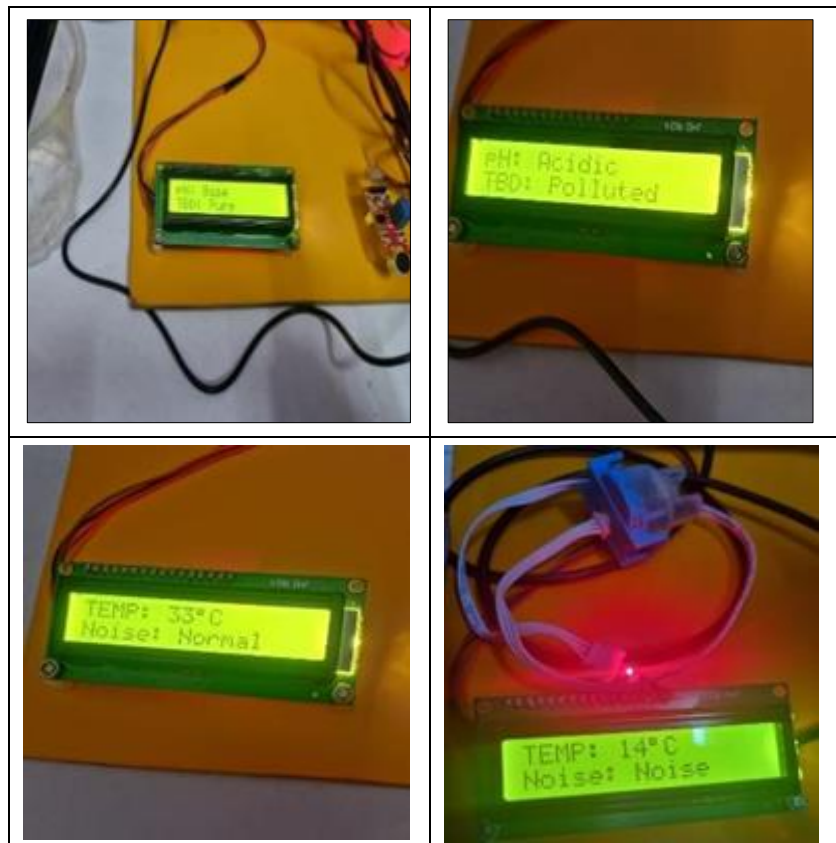

**Figure 5** This figure indicates the construction of Noise Pollution and Water Quality Detector

The above figure 5 shows the construction of Noise Pollution and Water Quality Detector, which uses the following concepts.

- Noise Pollution Sensors: These sensors detect and measure noise levels in the surrounding environment. They can be microphones or specialized sensors designed to capture specific frequency ranges.
- Water Quality Monitoring Sensors: These sensors measure various parameters such as pH, dissolved oxygen, turbidity, conductivity, temperature, and levels of pollutants like heavy metals or organic compounds.
- Control Interface: Buttons or touchscreens for user interaction, such as configuring settings or acknowledging.
- Servers or Cloud Platform: Data transmitted from monitoring units is collected, stored, and analyzed on a central server or cloud platform.
- Remote Access: Ability to access monitoring data and system status remotely, often through web-based dashboards or mobile apps.

### 5.1. Output

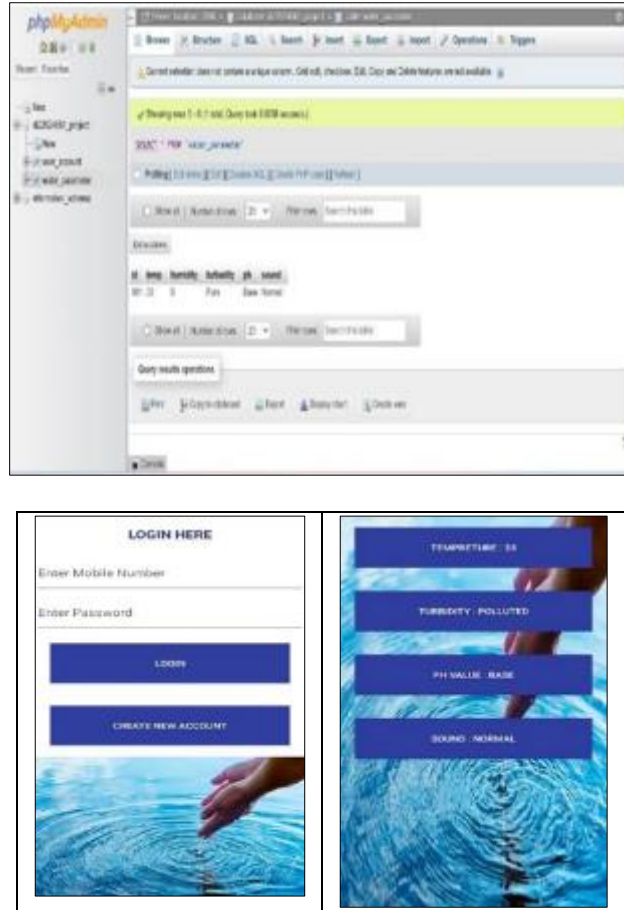

**Figure 6** This above figure shows the output in LCD board of Noise Pollution and Water Monitoring System

The above figure 6 shows the LCD (Liquid Crystal Display) board for a noise pollution and water quality monitoring system would present real-time data and alerts in a clear and accessible format.

- Current Noise Level : Real-time noise level in decibels (dB).

### 5.2. Frontend and Backend Page



**Figure 7** Frontend and Backend Page of Noise Pollution and Water Quality Monitoring System

## 6. Future scope

An IoT-based noise pollution and water monitoring system holds immense potential for addressing environmental concerns and ensuring public health and safety. Here's a breakdown of its future scope:

**Real-Time Monitoring:** IoT devices can continuously monitor noise levels and water quality parameters such as pH, turbidity, dissolved oxygen, and chemical contaminants. Real-time data collection allows for immediate detection of any deviations from acceptable levels, enabling prompt action to be taken.

**Data Analytics:** The collected data can be analyzed using advanced analytics techniques to identify patterns, trends, and correlations. This analysis can provide valuable insights into the sources of noise pollution and water contamination, helping authorities develop targeted mitigation strategies.

**Predictive Maintenance:** IoT sensors can also be used for predictive maintenance of water treatment facilities and infrastructure. By monitoring parameters such as flow rates and equipment performance, potential issues can be detected early, minimizing downtime and preventing costly repairs.

## 7. Conclusion

The noise and water quality monitoring system overpowers the problem of pollution in the all kinds of areas. It encourages new technologies and successfully upholds the concept of a healthy lifestyle. The system allow users to monitor the quantity of pollution in their surrounding on their cell phones using this system. Therefore, it is considered more reliable and efficient for the officials and citizens to monitor the environment. Allowing citizens to participate in the process adds value to it. As citizens are now equally aware and want to know where they are, this IoT concept is beneficial to public welfare. It is also implemented using the latest technology.

---

## Compliance with ethical standards

### *Disclosure of conflict of interest*

No conflict of interest to be disclosed.

---

## References

- [1] P. Patil, "Smart IoT based system for vehicle noise and pollution monitoring," 2017 International Conference on Trends in Electronics and Informatics (ICEI), 2017, pp. 322-326, do: 10.1109/ICOEI.2017.8300941.
- [2] Monira Mukta, Samia Islam, Surajit Das Barman, Ahmed Wasif, Reza IoT based Smart Water Quality Monitoring System IEEE 4th International Conference on Computer and Communication Systems, p. 669 - 673 Posted: 2019
- [3] Ajith Jerom , B Manimegalai , R Ilayaraja , V An IoT Based Smart Water Quality Monitoring System using Cloud 2020 International Conference on Emerging Trends in Information Technology and Engineering
- [4] Priyanka N. Bande, S.J. Nandedkar Low-Cost sensor network for real-time water quality measurement system Int. J. Innovat. Res. Sci. Eng. Technol., 5 (2016), pp. 20691-20696
- [5] M.N. Barabde, S.R. Danve Continuous water quality monitoring system for Water resources at remote places IJRCEE, 3 (2015), pp. 2320-9798.