



(RESEARCH ARTICLE)



Power quality improvement of PWM AC Chopper fed capacitor run induction motor using BFO, PSO and CSO Algorithm

Murali Narayanamurthy *, Annamalai Muthu, Gobimohan Sivasubramanian and Vidhya Prakash Rajendran

Electrical Engineering Department, Faculty of Engineering, University of Technology and Applied Sciences, Nizwa, Oman.

International Journal of Science and Research Archive, 2024, 11(02), 1855–1863

Publication history: Received on 09 March 2024; revised on 20 April 2024; accepted on 23 April 2024

Article DOI: <https://doi.org/10.30574/ijrsra.2024.11.2.0671>

Abstract

This paper exhibits performance enhancement of PWM AC chopper fed capacitor run induction motor by using optimization algorithm. The PWM AC chopper utilizes enhanced asymmetrical pulse width modulation technique by incorporating four pulses in quarter cycle. The switching instants are obtained optimally by bacteria foraging optimization, particle swarm optimization and cuckoo search optimization algorithm. The power quality parameters considered in this paper are total harmonic distortion of current, total harmonic distortion of voltage, power factor and efficiency. The simulation result shows that proposed algorithm shows better performance compared to other optimization techniques.

Keywords: Optimization; Turn off angle; Power factor; Harmonics; AC chopper

1. Introduction

Speed control of capacitor run induction motor is exhibited in domestic and industrial applications. The basic speed control technique is incorporated using variable resistor, but it has drawback of large power losses and more power dissipation [1]. The integral cycle control gives promising control compared to variable resistance. The power losses and heat dissipation are less. The limitations of integral cycle control are poor power factor, harmonic distortions are more and unstable variations of speed [2]. Hence the phase angle control shows better control compared to integral cycle control. The triggering angle is varied for different instants for different speed control. The ac voltage controller is placed in the main winding shows promising performance compared to auxiliary winding [3]. The placement of ac voltage controller in the auxiliary winding, at certain firing angles the variations causes unstable in nature. The performance of ac voltage controller is compared with single pulse width modulation technique. It is inferred that phase angle control shows better performance compared to single pulse width modulation technique [4]. The multiple pulse width modulation method gives enhanced operation compared to other techniques. The limitations of phase angle control are non-sinusoidal waveform, poor power factor at higher triggering angles and higher value of harmonic distortions [5]. Hence one type of multiple pulse width modulation technique is called as sinusoidal pulse width modulation [6]. In this article enhanced asymmetrical pulse width modulation technique incorporated by bacteria foraging optimization is compared with particle swarm optimization and cuckoo search optimization [7]. Enhanced asymmetrical pulse width modulation is a renowned technique for eliminating the harmonics in the output voltage [8]. Different optimization methodologies are incorporated for capacitor run induction motor for enhancing the performance under different loading conditions [9]. The genetic algorithm, particle swarm optimization, bee colony optimization, artificial neural networks, hybrid RGA-PS algorithms are used for implementing the asymmetrical pulse width modulation techniques [10]. In this paper section 2 consists of control of capacitor run induction motor, section 3 comprises of explanation of three algorithms, section 4 specifies comparison of results between conventional and proposed system. The permanent capacitor run induction motor has fixed capacitor for starting and running conditions.

* Corresponding author: Murali Narayanamurthy; Email: murali.naryanamurthy@utas.edu.om

The starting torque is higher compared to centrifugal type single phase induction motor. The main application is focused on domestic fans utilized in industry and house hold applications.

2. Experiment

2.1. Circuit diagram

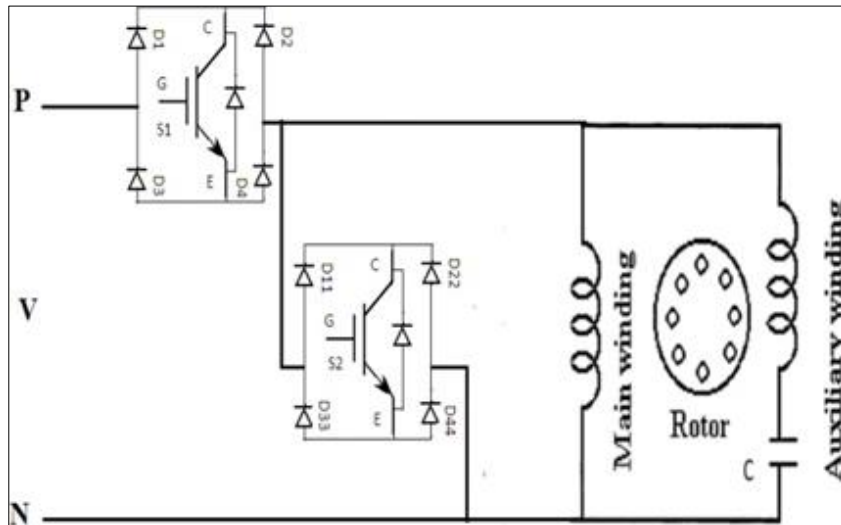

Figure 1 PWM AC chopper fed capacitor run induction motor

2.2. Related work

In symmetrical pulse width modulation, the pulses are of equal width and maintain full cycle symmetry. In enhanced asymmetrical pulse width modulation technique, the pulses are of different width and maintain quarter cycle symmetry. The switching on and off angles are varied [11]. The harmonics in the waveform is mathematically illustrated by Fourier series, the harmonic frequency component is separated using Fourier transforms. The harmonic elimination equation is non-linear and can be solved by numerical methods like Newton Raphson method [12]. The solution takes more iteration till it converges to reduced harmonic frequency components. Hence different optimization technique is evolved for solving these constraint problems [13]. The harmonic elimination methods use different methods such as genetic algorithm, particle swarm optimization, bee colony optimization and artificial intelligence techniques [14]. The objective of the paper is to improve power quality parameters by maximizing power factor and efficiency and minimizing the total harmonic distortion of voltage and total harmonic distortion of current. This paper focusses on obtaining the optimal switching angles by bacteria foraging optimization algorithm. Let the number of pulses be N. The switching instant for switching on the device is given as C1, C2 and C3 and switching off the device is given by D1, D2 and D3. The output voltage expressed in Fourier series is given as. In advanced methodology, the device turns on and turn off time are attained optimally. The waveforms are analyzed using fast Fourier transforms. The transcendental equations are solved using basic algorithm dynamic programming method. The disadvantage of setting the initial values for those equations is complex. The optimal switching angle arrived using various different techniques like ant colony, cuckoo search, evaporation based water cycle and other new algorithms.

$$V_o = \sqrt{2} V_i \left[F_o + \sum_{m=1}^{\infty} (F_n \sin(m\omega t) + F_n \cos(m\omega t)) \right] \dots\dots\dots (1)$$

$$V_o = \sqrt{2} V_i \sum_{m=1}^{\infty} (F_m \sin(m\omega t)) \dots\dots\dots(2)$$

F1 is given as

$$F_1 = \frac{1}{\pi} \sum_{q=1}^M \left[D_q - C_q - \frac{\sin 2D_q - \cos 2C_q}{2} \right] \dots\dots\dots (3)$$

F_n is given as follows

$$F_n = \frac{1}{\pi} \sum_{q=1}^M \frac{\sin(m-1)D_q - \sin(m-1)C_q}{m-1} - \frac{\sin(m+1)D_q - \sin(m+1)C_q}{m+1} \dots\dots\dots (4)$$

$$THD_v = \frac{\sqrt{\sum_{m=3}^{\infty} V_{on}^2}}{V_1} \dots\dots\dots (5)$$

$$THD_i = \frac{\sqrt{\sum_{m=3}^{\infty} I_{on}^2}}{I_1} \dots\dots\dots (6)$$

The problem formulation is attained for the main objective is to minimizing the total harmonic distortion at the output [15]. The optimum switching angles are required for the enhanced asymmetrical pulse width modulation of ac chopper.

$$Min_{A,B} G = \sqrt{[(C_1 - V_{ref})^2 + C_3^2 + C_5^2 + \dots C_n^2]} \dots\dots\dots (7)$$

The equation is mentioned with minimization [16]

$$0 \leq C_1 \leq D_1 \leq \phi \dots\dots \leq C_m \leq D_m \leq B_n \dots\dots\dots (8)$$

Where V_{ref} is the reference output voltage, $N=4$ is the number pulses in quarter cycle. A and B turn on and off switching instants. B_{max} is maximum switching angle and the value is 90 degrees. Φ is the boundary switching angles, for each set of pulse the boundary is 22.5 degrees.

3. Methodology

Particle swarm optimization has been proposed by Ebberhart and Kennedy in 1995 [16]. The basic algorithm is resemblance of bird flock movement. The searching behavior of food and finding the best source location is the nature’s creativity [17]. The birds will transmit the information to other birds and reach the optimum location of food source. The bird is moving from one place to another is the solution swarm and converges to optimist solution. The best solution is achieved by the co-operation of individual swarm [18]. The main objective of particle swarm optimization is to find minimum of a function. After every iteration the fitness of objective function is determined for convergence. The algorithm steps are given as follows

- Step 1: Initialize the parameters with positions and velocities in random of search space. Initialize Pbest and Gbest.
- Step 2: The velocity and particle are updated using the below equation for every iteration.
- Step 3: The particle position is updated
- Step 4: The particle position is updated and compared with the best positions of local and global values. When the current position has best values compared to Pbest and Gbest then the present location is set to corresponding values for optimum solution in the search space.
- Step 5: The optimization algorithm process completes when the solution is converged with good fitness value.

The objective function is minimized for different iterations and the Pbest and Gbest values are the solutions from the search space [19]. Cuckoo search optimization is nature inspired optimization algorithm analogous to other optimization like genetic, particle swarm, ant colony, bee colony and many other techniques [20]. The host bird egg is removed and increases the productivity. The best behaviors of cuckoo are it lays the egg before the host bird lays the egg and hence it creates a space for them. When the host bird identifies as alien egg it discards present nest and form a new one. The best behavior is the cuckoo lays the egg at different nest of host bird [21]. When any one of them failed or

nest is lost then the other egg will be hatching and next generation is produced. There are three important step is to be evolved for the optimization. of cuckoo search algorithm. Step one is each cuckoo bird lays one egg and places in random direction. The second step is the next generation is carried out by the best eggs and the final step is egg laid by a cuckoo is discovered by the hosts bird at a probability from $[0, 1]$ along with the condition of fixed set of nest. The cuckoo search optimization parameters specified are maximum generation, switching parameter, initial population, and levy exponent, upper and lower ranges.

The algorithm is depicted as follows

- Step 1: initialize the parameters for the cuckoo search algorithm.
- Step 2: randomly generate the parameters in the search space.
- Step 3: evaluate the fitness function for each nest and find the best value
 $Fitness = 1 - K$
 where K is to be minimized
- Step 4: choose a cuckoo and randomly choose the levy walk and inculcate the local fitness function.
- Step 5: evaluate the local fitness function and choose the nest randomly.
- Step 6: compare the chosen nest with global fitness function and replace it by new nest.
- Step 7: the probabilities of bad nest are uninhibited and maintain the new nest with best solution by ranking it and choose the best one.

Bacteria foraging optimization proposed first by Passino [22] is based on real time E. coli present in the intestines of human body. The basic operation of E. coli bacteria is when the nutrients available it forages in small steps and grows, while in noxious environment bacteria dies and moves away. The real bacteria forage shortest path and find the new position with high fitness value [23]. This phenomenon leads to global optimum solution. The movement of each bacterium depends upon the coordinate of the search space. Initially the coordinate of bacterium is chosen randomly, when the nutrients available in the bacterium forage to a new position and the objective function is minimized. This ultimate effect causes the set of bacteria to locate the best position and optimum solution is achieved. Under bad environment the bacteria move away and optimum position is not reached. The bacteria foraging algorithm is presented below.

- Step 1: Elimination and dispersal loop $l = l + 1$
- Step 2: Reproduction loop $k = k + 1$
- Step 3: Chemotaxis loop $j = j + 1$
 Calculate fitness function $Q(i,j,k,l)$. Save this value in $Q_{last} = Q(i,j,k,l)$ so that we can find better fitness cost. In tumble operation it generates a direction vector $\Delta(i)$ which denotes unit values in random direction from negative to positive $[-1,1]$ and $L(i)$ specifies the step length.
- Step 4: if $j < \text{number of chemotactic step}$, then go to step 3 as chemotaxis step is not complete
- Step 5: in reproduction with the present values of k, l for each value of $i=1,2,\dots,\text{number of bacteria}$, calculate global fitness function. In this higher cost function bacteria will die and lower cost function will grow and it split in to two asexually. This keeps the search space constant.
- Step 6: if $k < \text{number of reproductive steps}$, go to step 2 and restart the chemotaxis process
- Step 7: elimination and dispersal process, by eliminating the bacterium and disperse the remaining bacteria in a random location. When $l < \text{number of elimination and dispersal}$ go to step 2 or when the objective function converges it comes to an end.

4. Results and Discussion

The bacteria foraging optimization algorithm was computed by using MATLAB software. The parameters taken are listed below.

Dimension of search space: 6
 Number of bacteria: 20
 Number of chemotactic steps: 10
 Limits for length of swim: 4
 Number of reproductive steps: 4
 Number of elimination and dispersal steps: 2
 Probability of elimination: 0.75

The proposed enhanced asymmetrical pulse width modulation by bacteria foraging optimization is compared with particle swarm optimization and cuckoo search optimization. The existing technique of asymmetrical pulse width modulation by artificial bee colony algorithm is compared with other optimization algorithm for the output voltage of 160V is shown in the Table 1.

Table 1 Comparative analysis of different techniques

Method	%THDv	%THDi	Power factor
BFO	0.94	0.63	0.93
CSO	1.16	0.70	0.92
BCO [5]	12.15	40.15	0.81
PSO	1.41	1.41	0.92

4.1. Power factor versus output voltage

The enhanced pulse width modulation technique shows promising performance for speed control of capacitor run induction motor. The design of switching angles is obtained using optimization techniques. This methodology is a family of selective harmonic elimination techniques for improving power quality from conventional controllers. The different optimization methods considered for enhanced asymmetrical pulse width modulation for PWM AC chopper fed capacitor run induction motor are bacteria foraging optimization is compared with particle swarm optimization and cuckoo search optimization. The power factor of PWM AC chopper fed capacitor run induction motor is compared for different optimization techniques such as PSO, CSO and BFO is incorporated for enhanced asymmetrical pulse width modulation technique. At 160 V, EAPWM incorporated by BFO has 0.01 higher value of power factor compared to EAPWM incorporated by CSO. At 160 V, EAPWM incorporated by BFO has 0.01 higher value of power factor compared to EAPWM incorporated by PSO. This infers that PWM AC chopper incorporated by BFO methodology using EAPWM method has better power factor compared to PSO and CSO techniques (Fig 2)

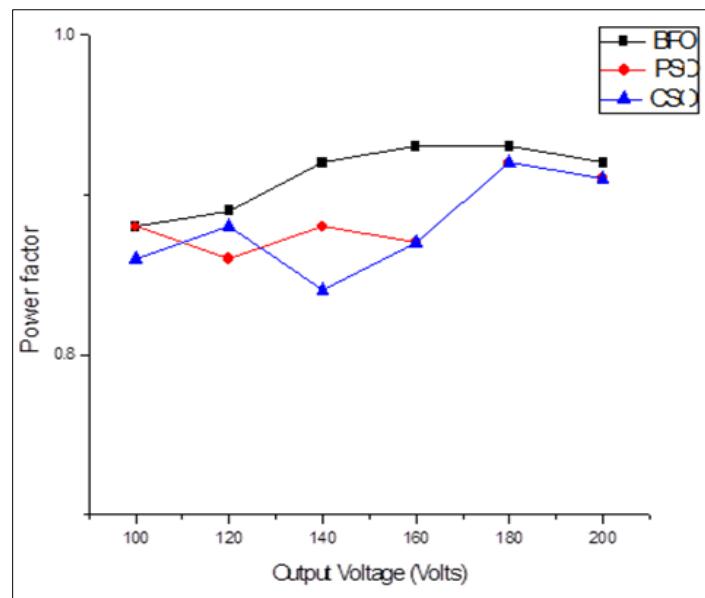

Figure 2 Power factor versus output voltage

4.2. %THD voltage vs output voltage

The %THD voltage of PWM AC chopper fed capacitor run induction motor is compared for different optimization techniques such as PSO, CSO and BFO for the switching angle design of enhanced asymmetrical pulse width modulation technique. At 160 V, EAPWM incorporated by BFO has 0.22% lesser value of voltage THD compared to EAPWM incorporated by CSO. At 160 V, EAPWM incorporated by BFO has 0.47% lesser value of voltage THD compared to EAPWM incorporated by PSO. It implies that the PWM AC chopper incorporating BFO methodology in utilizing EAPWM method has better % voltage THD compared to PSO and CSO techniques (Fig 3)

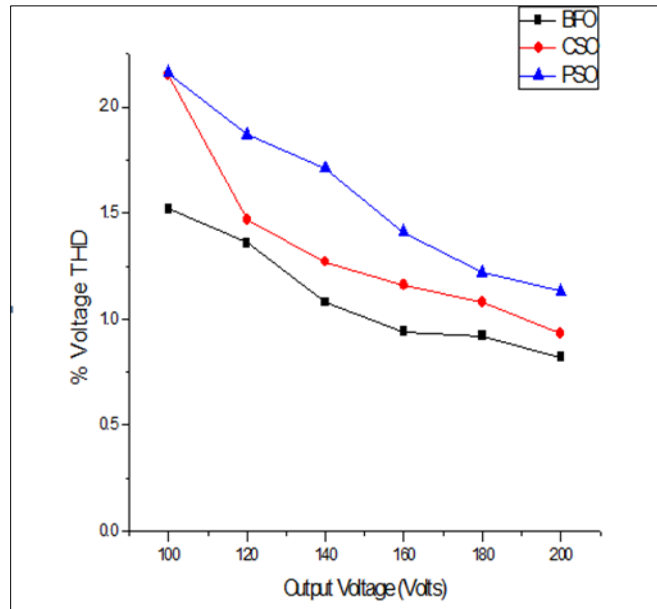

Figure 3 %THD voltage vs output voltage

4.3. %THD current vs output voltage

The %THD current of PWM AC chopper fed capacitor run induction motor is compared for different optimization techniques such as PSO, CSO and BFO for the switching angle design of enhanced asymmetrical pulse width modulation technique. At 160 V, EAPWM incorporated by BFO has 0.07% lesser value of current THD compared to EAPWM incorporated by CSO. At 160 V, EAPWM incorporated by BFO has 0.78% lesser value of current THD compared to EAPWM incorporated by PSO. It infers that the PWM AC chopper incorporating BFO methodology utilizing EAPWM technique has better % current THD compared to PSO and CSO techniques (Fig 4)

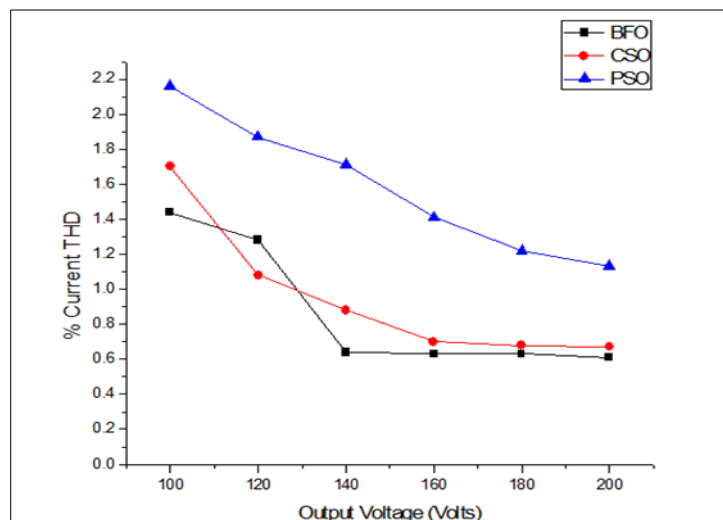

Figure 4 %THD current vs output voltage

4.4. %Efficiency vs output voltage

The efficiency of PWM AC chopper fed capacitor run induction motor is compared for different optimization techniques such as PSO, CSO and BFO by implementing enhanced asymmetrical pulse width modulation technique. At 160 V, EAPWM incorporated by BFO has 7.98% higher value of efficiency compared to EAPWM incorporated by CSO. At 160 V, EAPWM incorporated by BFO has 11.65% higher value of efficiency compared to EAPWM incorporated by PSO. This implies that the PWM AC chopper incorporating BFO methodology for EAPWM has better efficiency compared to PSO and CSO techniques (Fig 5)

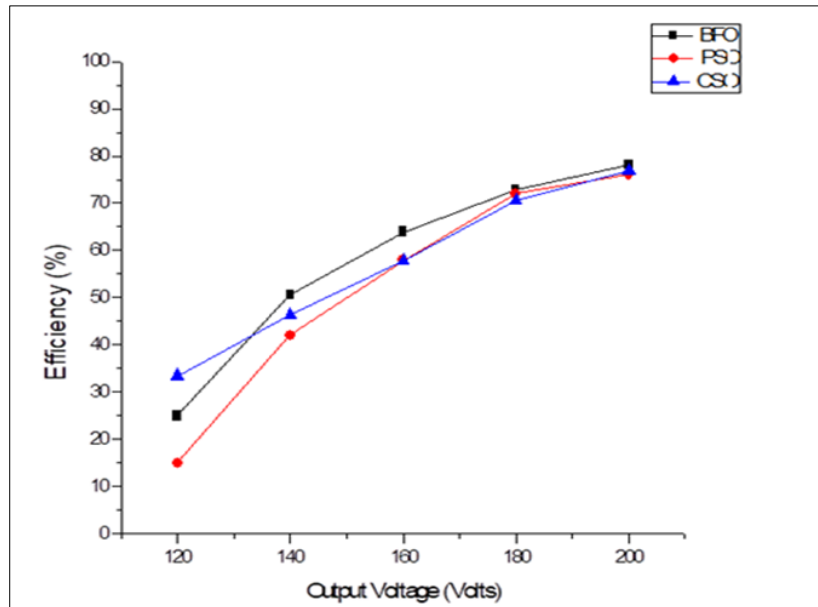

Figure 5 %Efficiency vs output voltage

5. Conclusion and Recommendations

This paper compares optimization algorithm for the speed control of capacitor run induction motor with good power quality. The power quality parameters considered in this paper are efficiency, power factor, total harmonic distortion of voltage and current. The controlling techniques implemented for PWM AC chopper are enhanced asymmetrical pulse width modulation by bacteria foraging optimization, cuckoo search optimization and particle swarm optimization. The simulation results show that power quality improvement by proposed optimization is better compared to other optimization techniques. In particle swarm optimization, the initial parameter is difficult to identify for optimum convergence. Due to levy flight behavior the convergence is affected and leads to increased time to get necessary solution. Hence by these demerits the bacteria foraging optimization is better compared to cuckoo search and particle swarm optimization. This work can be compared with the other techniques like particle swarm optimization, cuckoo search optimization and proposed technique for the enriched asymmetrical pulse width modulation for capacitor run induction motor.

Compliance with ethical standards

Acknowledgements

The authors like to thank our HOD of Engineering department & UTAS Management for support.

Disclosure of conflict of interest





No conflict of interest to be disclose.

References

- [1] A.E.Kabeel, Z.M.Omara, M.M.Younes, Techniques used to improve the performance of the stepped solar still- A review, Renewable and Sustainable Energy Reviews. 2015 Dec;46(2):178–188.
- [2] K.Sundareswaran, An improved energy saving scheme for capacitor run induction motor, IEEE transaction on industrial electronics. 2001 Feb; 48(1): pp. 238-240.
- [3] K.Sundareswaran, N.rajasekar and V.T.Sreedevi, Performance comparison of capacitor run induction motors supplied from ac voltage regulator and spwm ac chopper, IEEE transactions on industrial electronics. 2006 Jun; 53(3): 990- 993

- [4] Aravindan A.N and Simon Alphonse J, Investigation of harmonic distortion in line and load currents of the sinusoidal pulse width modulated single phase AC chopper, IEEE conference.2014.
- [5] Wanchai Khamsen, Apinan Aurasopon and Chanwit Boobchuay,Optimal switching pattern for pwm ac-ac converters using bee colony optimization,Journal of power electronics. 2014 Mar;14(2):362-368
- [6] Panithi Sanjith and Apinan Aurasopon, Asymmetrical pwm for harmonics reduction and power factor improvement in pwm ac choppers using bee colony optimization, Journal of power electronics. 2015 Jan;15(1): 227-234.
- [7] M. S. A. Dahidah and M. V. C. Rao, A hybrid genetic algorithm for selective harmonic elimination PWM AC/AC converter control, Electric Engineering. 2007; 89(4):285-291.
- [8] Kouzou, S. Saadi, M.O. Mahmoudi, and M. S. Boucherit, Voltage quality enhancement of PWM AC voltage controller using particle swarm optimization, in Proc. POWERENG. 2009: 309-314.
- [9] S. M. Sadr, M. Monfared, and H. R. Mashhadi, Application of PSO for Selective Harmonic Elimination in a PWM AC/AC Voltage Regulator, in Proc. ICCKE. 2012: 62-65.
- [10] Sun J, Beineke S., Grotstollen H, Optimal PWM based on real-time solution of harmonic elimination equations, IEEE Trans Industrial Electronics. 1996 Jul; 11(4): 612–621.
- [11] D. H. Jang, G. H. Choe, and M. Ehsani, Asymmetrical PWM technique with harmonic elimination and power factor control in AC choppers, IEEE Trans. Power Electronics. 1995:10(2):175- 184.
- [12] J. Bindu, S. Muralidharan, S. Selvaperumal, and M. Muhaidheen, Genetic algorithm based selective harmonic elimination in PWM AC-AC converter, in Proc. ICONRAEeCE. 2011: 393-397.
- [13] S.Mahendran, I.Gnanambal and A.Maheswari, Fpga based genetic algorithm implementation for ac chopper fed induction motor, international journal of electronics. 2016 Apr;103(12): 2029-2041.
- [14] Nabil A.Ahmed, KeniAmei and MaasakiSakui, AC chopper voltage controller fed single phase induction motor employing symmetrical pwm technique, Electric power system research. 2000 Jul;55(1):15-25.
- [15] P. piyarungsan and S. kaitwanidvilai, Harmonic reduction technique in PWM AC voltage controller using particle swarm optimization and artificial neural network', in Proc. IMECS. 2010:2.
- [16] K. Al-Othman, N. A. Ahmed, A. M. Al-Kandari, and H. K. Ebraheem, Selective harmonic elimination of PWM AC/AC voltage controller using hybrid RGA-PS approach', Journal of World Academy of Science, Engineering and Technology. 2007;1(5):140-146.
- [17] K. Sundareswaran and A. P. Kumar, Voltage harmonic elimination in PWM A.C. chopper using genetic algorithm, in Proc. IEE Electr. Power Appl. 2004 Jan;151(1): 26-35.
- [18] S. S. Rao and S. N. Warangal, Improving voltage regulation and harmonic elimination using genetic algorithm in PWM chopper ,in Proc. INTELEC. 2005: 449-454.
- [19] P. Jitta, S. Kaitwanidvilai, and A. Ngaopitakkul, Switching angle design for pulse width modulation AC voltage controller using genetic algorithm and distributed artificial neural network , in Proc. IMECS.2011:970-974.
- [20] Xiin-She Yang and Deb, Engineering Optimization by Cuckoo Search, Journal of Mathematical Modelling and Numerical Optimization. 2010 Dec;1(4).
- [21] Kennedy J. and Eberhart R.C, Particle Swarm Optimization, Proc. IEEE Int. Conf. on N.N. 1995:1942-1948.
- [22] Mohammad Moradi, Ali Sadollah, Hoda Eskandar, Hadi Eskandar, The application of water cycle algorithm to portfolio selection, Economic research –Ekonomiska istra zivanja. 2017;30(1):1277-1299.
- [23] Kong Yanjun, Mei Yadong, Li Weiman, Wang Xianxun, Ben Yue, "An Enhanced water cycle algorithm for optimization of multi reservoir systems", in proc IEEE,.2021

Authors short Biography

	<p>Dr.N.Murali has 22 years of teaching experience. Working as a Lecturer in the Department of Electrical Engineering, University of Technology and Applied Sciences Nizwa, Oman. His current areas of research are Optimization techniques, power electronics and drives, electrical machines design using Ansys, Power electronics application in power system, IOT based renewable energy systems and power electronics application in renewable energy systems. He has published 18 research papers in international journals and 10 papers in international and national conferences. He is a Life member of System society of India.</p>
	<p>Dr. Annamalai Muthu has 21 years of teaching experience. Working as a Lecturer in the Department of Electrical Engineering, University of Technology and Applied Sciences Nizwa, Oman. His current areas of research are Optimization techniques, power electronics and drives, electrical machines design using Ansys, and power electronics application in power system, IOT based renewable energy systems and power electronics application in renewable energy systems. He has published 12 research papers in international journals and 15 papers in international and national conferences</p>
	<p>Dr.Gobimohan Sivasubramanian is an Indian, Lecturer, Department of Electrical Engineering, University of Technology and Applied Sciences Nizwa, Oman. He has around 28 years of teaching experience. His area of interest includes Renewable energy, Power Electronics, Soft Computing Techniques. He has the ability to look on the better side of life instead of focusing on problems. He has published 15 research papers in international journals and 5 papers in international and national conferences. He is a Life Member Indian society for Technical education.</p>
	<p>Mr.Vidhya Prakash Rajendran is a dynamic researcher and educator with over 13 years of experience, currently pursuing his Ph.D at Kalasalingam University. His focus on Cyber-Physical Systems(CPS) encompasses a breadth of topics, from systems to security. His work aims to innovate solutions enhancing efficiency and security in CPS applications. Passionate about teaching, he mentors students, nurturing their academic growth while contributing significantly to CPS knowledge advancement.</p>